

Installation Instructions

MicroLogix™ 1200 Programmable Controllers

(Cat. No. 1762-L24AWA, 1762-L24BWA, 1762-L24BXB, 1762-L40AWA, 1762-L40BWA, 1762-L40BXB, 1762-L24AWAR, 1762-L24BWAR, 1762-L24BXBR, 1762-L40AWAR, 1762-L40BWAR, 1762-L40BXBR)

http://literature.rockwellautomation.com/idc/groups/literature/documents/in/1762-in006_-mu-p.pdf

FR

Cette publication est disponible en français sous forme électronique (fichier PDF). Pour la télécharger, rendez-vous sur la page Internet indiquée ci-dessus.

IT

Questa pubblicazione è disponibile in Italiano in formato PDF. Per scaricarla collegarsi al sito Web indicato sopra.

DE

Diese Publikation ist als PDF auf Deutsch verfügbar. Gehen Sie auf die oben genannte Web-Adresse, um nach der Publikation zu suchen und sie herunterzuladen.

ES

Esta publicación está disponible en español como PDF. Diríjase a la dirección web indicada arriba para buscar y descarga esta publicación.

PT

Esta publicação está disponível em português como PDF. Vá ao endereço web que aparece acima para encontrar e fazer download da publicação.

Installation Instructions

MicroLogix 1200 Programmable Controllers

(Cat. No. 1762-L24AWA, 1762-L24BWA, 1762-L24BXB, 1762-L40AWA, 1762-L40BWA, 1762-L40BXB, 1762-L24AWAR, 1762-L24BWAR, 1762-L24BXHR, 1762-L40AWAR, 1762-L40BWAR, 1762-L40BXHR)

Inside . . .	
Important User Information	4
For More Information	5
Overview	6
Controller Description	7
Hazardous Location Considerations	8
Mounting the Controller	10
Connecting 1762 I/O Expansion Modules	14
Wiring the Controller	15
Specifications	21

Important User Information

Solid state equipment has operational characteristics differing from those of electromechanical equipment. *Safety Guidelines for the Application, Installation and Maintenance of Solid State Controls* (Publication SGI-1.1 available from your local Rockwell Automation sales office or online at <http://www.ab.com/manuals/gi>) describes some important differences between solid state equipment and hard-wired electromechanical devices. Because of this difference, and also because of the wide variety of uses for solid state equipment, all persons responsible for applying this equipment must satisfy themselves that each intended application of this equipment is acceptable.





In no event will Rockwell Automation, Inc. be responsible or liable for indirect or consequential damages resulting from the use or application of this equipment.

The examples and diagrams in this manual are included solely for illustrative purposes. Because of the many variables and requirements associated with any particular installation, Rockwell Automation, Inc. cannot assume responsibility or liability for actual use based on the examples and diagrams.

No patent liability is assumed by Rockwell Automation, Inc. with respect to use of information, circuits, equipment, or software described in this manual.

Reproduction of the contents of this manual, in whole or in part, without written permission of Rockwell Automation, Inc. is prohibited.

Throughout this manual we use notes to make you aware of safety considerations.

<p>WARNING</p> 	<p>Identifies information about practices or circumstances that can cause an explosion in a hazardous environment, which may lead to personal injury or death, property damage, or economic loss.</p>
<p>IMPORTANT</p>	<p>Identifies information that is critical for successful application and understanding of the product.</p>
<p>ATTENTION</p> 	<p>Identifies information about practices or circumstances that can lead to personal injury or death, property damage, or economic loss. Attentions help you:</p> <ul style="list-style-type: none"> • identify a hazard • avoid a hazard • recognize the consequence
<p>SHOCK HAZARD</p> 	<p>Labels may be located on or inside the drive to alert people that dangerous voltage may be present.</p>
<p>BURN HAZARD</p> 	<p>Labels may be located on or inside the drive to alert people that surfaces may be dangerous temperatures.</p>

For More Information

Related Publications

For	Refer to this Document	Pub. No.
A more detailed description of how to install and use your MicroLogix 1200 programmable controller and expansion I/O system.	MicroLogix™ 1200 Programmable Controllers User Manual	1762-UM001
A reference manual that contains data and function files, instruction set, and troubleshooting information for MicroLogix 1200 and MicroLogix 1500.	MicroLogix™ 1200 and MicroLogix™ 1500 Instruction Set Reference Manual	1762-RM001
Information on installing and using 1762 expansion I/O modules.	Installation Instructions are included with each module. Also available via www.theautomationbookstore.com .	1762-INxxx
More information on proper wiring and grounding techniques.	Industrial Automation Wiring and Grounding Guidelines	1770-4.1

If you would like a manual, you can:

- download a free electronic version from the internet:
<http://literature.rockwellautomation.com>
- purchase a printed manual by contacting your local Allen-Bradley distributor or Rockwell Automation representative

Overview

MicroLogix™ 1200 Controllers are suitable for use in an industrial environment when installed in accordance with these instructions. Specifically, this equipment is intended for use in clean, dry environments (Pollution degree 2⁽¹⁾) and to circuits not exceeding Over Voltage Category II⁽²⁾ (IEC 60664-1).⁽³⁾

Install your controller using these installation instructions.

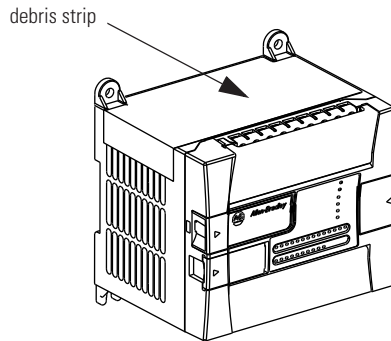

ATTENTION



Do not remove the protective debris strip until after the controller and all other equipment in the panel near the controller is mounted and wiring is complete. Once wiring is complete, remove protective debris strip. Failure to remove strip before operating can cause overheating.

ATTENTION



Electrostatic discharge can damage semiconductor devices inside the controller. Do not touch the connector pins or other sensitive areas.

- ⁽¹⁾ Pollution Degree 2 is an environment where, normally, only non-conductive pollution occurs except that occasionally a temporary conductivity caused by condensation shall be expected.
- ⁽²⁾ Over Voltage Category II is the load level section of the electrical distribution system. At this level transient voltages are controlled and do not exceed the impulse voltage capability of the product's insulation.
- ⁽³⁾ Pollution Degree 2 and Over Voltage Category II are International Electrotechnical Commission (IEC) designations.

Controller Description

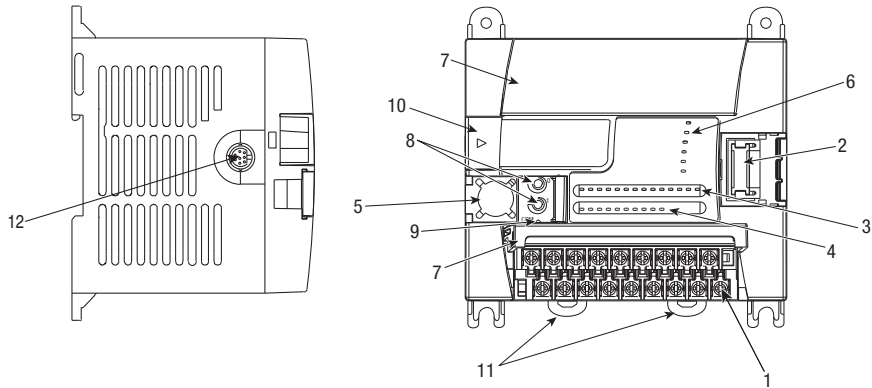

Item	Description	Item	Description
1	Terminal Blocks (Removable Terminal Blocks on 40-point controllers only)	7	Terminal Doors and Label
2	Bus Connector Interface to Expansion I/O	8	Trim Pots
3	Input LEDs	9	Default Communications Push Button
4	Output LEDs	10	Memory Module Port Cover ⁽¹⁾ -or- Memory Module and/or Real Time Clock ⁽²⁾
5	Communication Port (Channel 0)	11	DIN Rail Latches
6	Status LEDs	12	Programmer/HMI Port (Equipped with 1762-LxxxxR controllers only)

⁽¹⁾ Shipped with controller

⁽²⁾ Optional equipment.

Catalog Number	Description		
	Input Power	Inputs	Outputs
1762-L24AWA, -L24AWAR	120/240V ac	(14) 120V ac	(10) relay
1762-L24BWA, -L24BWAR	120/240V ac	(10) 24V dc (4) fast 24V dc	(10) relay
1762-L24BXB, -L24BXBR	24V dc	(10) 24V dc (4) fast 24V dc	(5) relay, (4) 24V dc FET (1) high-speed 24V dc FET
1762-L40AWA, -L40AWAR	120/240V ac	(24) 120V ac	(16) relay
1762-L40BWA, -L40BWAR	120/240V ac	(20) 24V dc (4) fast 24V dc	(16) relay
1762-L40BXB, -L40BXBR	24V dc	(20) 24V dc (4) fast 24V dc	(8) relay, (7) 24V dc FET (1) high-speed 24V dc FET

Hazardous Location Considerations

This equipment is suitable for use in Class I, Division 2, Groups A, B, C, D or non-hazardous locations only. The following WARNING statement applies to use in hazardous locations.

WARNING



EXPLOSION HAZARD

- Substitution of components may impair suitability for Class I, Division 2.
- Do not replace components or disconnect equipment unless power has been switched off.
- Do not connect or disconnect components unless power has been switched off.
- This product must be installed in an enclosure. All cables connected to the product must remain in the enclosure or be protected by conduit or other means.
- All wiring must comply with N.E.C. article 501-4(b).

Use only the following communication cables in Class I, Division 2 hazardous locations.

Environment Classification	Communication Cables
Class I, Division 2 Hazardous Environment	1761-CBL-PM02 Series C or later
	1761-CBL-HM02 Series C or later
	1761-CBL-AM00 Series C or later
	1761-CBL-AP00 Series C or later
	2707-NC8 Series B or later
	2707-NC10 Series B or later
	2707-NC11 Series B or later

Environnements dangereux

Cet équipement est conçu pour être utilisé dans des environnements de Classe I, Division 2, Groupes A, B, C, D ou non dangereux. La mise en garde suivante s'applique à utilisation en environnements dangereux.

AVERTISSEMENT



DANGER D'EXPLOSION

- La substitution de composants peut rendre cet équipement impropre à une utilisation en environnement de Classe I, Division 2.
- Ne pas remplacer de composants ou déconnecter l'équipement sans s'être assuré que l'alimentation est coupée.
- Ne pas connecter ou déconnecter des composants sans s'être assuré que l'alimentation est coupée.
- Ce produit doit être installé dans une armoire. Tous les câbles connectés à l'appareil doivent rester dans l'armoire ou être protégés par un conduit ou tout autre moyen.
- L'ensemble du câblage doit être conforme à la réglementation en vigueur dans les pays où l'appareil est installé.

Utiliser uniquement les câbles de communication suivants dans les environnements dangereux de Classe I, Division 2.

Classification des environnements	Câbles de communication
Environnement dangereux de Classe I, Division 2	1761-CBL-PM02 série C ou ultérieure
	1761-CBL-HM02 série C ou ultérieure
	1761-CBL-AM00 série C ou ultérieure
	1761-CBL-AP00 série C ou ultérieure
	707-NC8 série B ou ultérieure
	2707-NC10 série B ou ultérieure
	2707-NC11 série B ou ultérieure

Mounting the Controller

General Considerations

Most applications require installation in an industrial enclosure to reduce the effects of electrical interference and environmental exposure. Locate your controller as far as possible from power lines, load lines, and other sources of electrical noise such as hard-contact switches, relays, and AC motor drives. For more information on proper grounding guidelines, see the *Industrial Automation Wiring and Grounding Guidelines* publication 1770-4.1.

ATTENTION



Vertical mounting is not recommended due to thermal considerations.

ATTENTION



Be careful of metal chips when drilling mounting holes for your controller or other equipment within the enclosure or panel. Drilled fragments that fall into the controller could cause damage. Do not drill holes above a mounted controller if the protective debris strips have been removed.

Mounting Dimensions

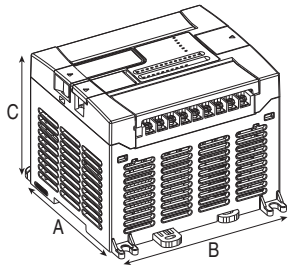

1762-L24AWA, 1762-L24BWA, 1762-L24BXB,
1762-L24AWAR, 1762-L24BWAR, 1762-L24BXBR

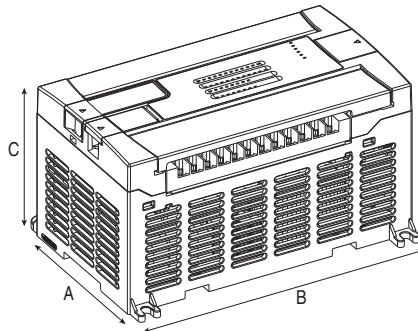

1762-L40AWA, 1762-L40BWA, 1762-L40BXB,
1762-L40AWAR, 1762-L40BWAR, 1762-L40BXBR

Dimension	1762-					
	L24AWA, L24AWAR	L24BWA, L24BWAR	L24BXB, L24BXBR	L40AWA, L40AWAR	L40BWA, L40BWAR	L40BXB, L40BXBR
A	90 mm (3.5 in.)			90 mm (3.5 in.)		
B	110 mm (4.33 in.)			160 mm (6.30 in.)		
C	87 mm (3.43 in.)			87 mm (3.43 in.)		

Controller Spacing

The controller mounts horizontally, with the expansion I/O extending to the right of the controller. Allow 50 mm (2 in.) of space on all but the right side for adequate ventilation, as shown below.

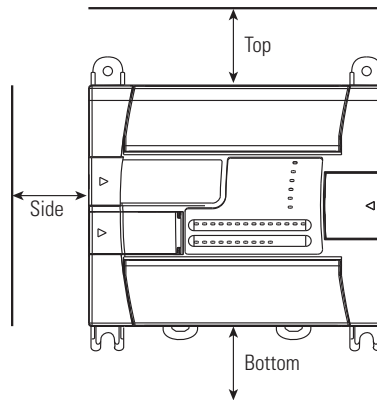

DIN Rail Mounting

The maximum extension of the latch is 14 mm (0.55 in.) in the open position. A flat-blade screwdriver is required for removal of the controller. The controller can be mounted to EN50022-35x7.5 or EN50022-35x15 DIN rails. DIN rail mounting dimensions are shown below.

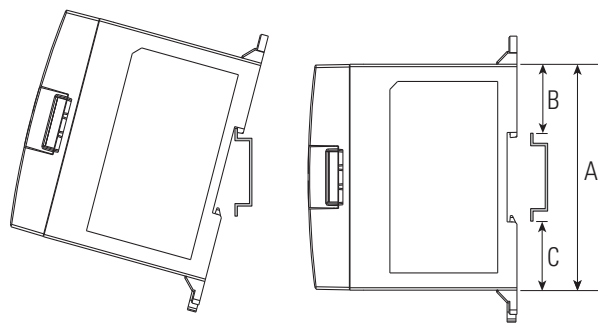

Dimension	Height
A	90 mm (3.5 in.)
B	27.5 mm (1.08 in.)
C	27.5 mm (1.08 in.)

To install your controller on the DIN rail:

1. Mount your DIN rail. (Make sure that the placement of the controller on the DIN rail meets the recommended spacing requirements, see Controller Spacing on page 12. Refer to the mounting template inside the back cover of this document.)
2. Close the DIN latch, if it is open.
3. Hook the top slot over the DIN rail.
4. While pressing the controller down against the top of the rail, snap the bottom of the controller into position.
5. Leave the protective debris strip attached until you are finished wiring the controller and any other devices.

To remove your controller from the DIN rail:

1. Place a flat-blade screwdriver in the DIN rail latch at the bottom of the controller.
2. Holding the controller, pry downward on the latch until the latch locks in the open position.
3. Repeat steps 1 and 2 for the second DIN rail latch.
4. Unhook the top of the DIN rail slot from the rail.

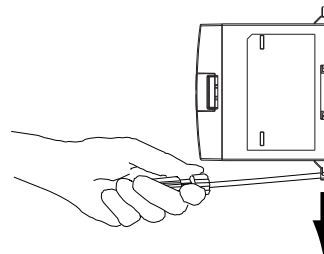
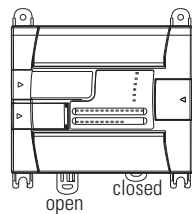

Panel Mounting

Mount to panel using #8 or M4 screws. To install your controller using mounting screws:

1. Remove the mounting template from inside the back cover of this document.
2. Secure the template to the mounting surface. (Make sure your controller is spaced properly. See Controller Spacing on page 12.)
3. Drill holes through the template.
4. Remove the mounting template.
5. Mount the controller.
6. Leave the protective debris strip in place until you are finished wiring the controller and any other devices.

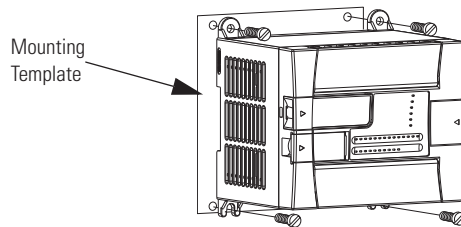

Connecting 1762 I/O Expansion Modules

ATTENTION



Remove power to the system before installing expansion I/O or damage to the controller may result.

Connect 1762 I/O after mounting the controller. Remove the expansion port cover to install expansion I/O modules. Plug the ribbon cable connector into the bus connector. Replace the cover as shown below.

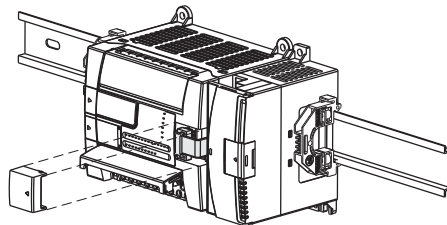

IMPORTANT

Ensure that your system power supply is sufficient to support the number of I/O modules you are installing in the system. A system loading worksheet is provided in the *MicroLogix 1200 Programmable Controllers User Manual*, publication 1762-UM001.

For detailed information on using expansion I/O, refer to the installation instructions for your expansion module.

Wiring the Controller

Terminal Block Layouts

TIP

The shading in the following terminal block illustrations indicates which terminals are tied to which commons.

1762-L24AWA,
1762-L24AWAR

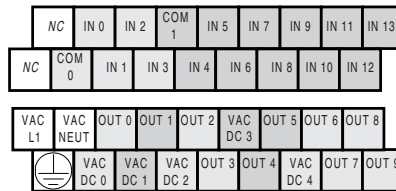

1762-L24BWA,
1762-L24BWAR

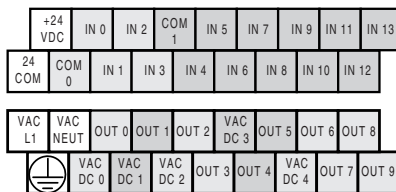

1762-L24BXB,
1762-L24BXHR

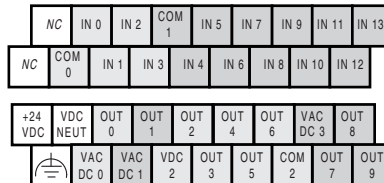

1762-L40AWA,
1762-L40AWAR

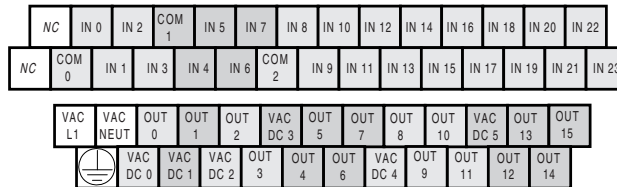

1762-L40BWA,
1762-L40BWAR

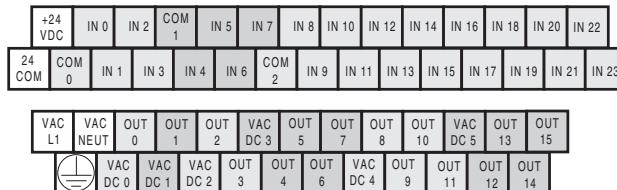

1762-L40BXB,
1762-L40BXHR

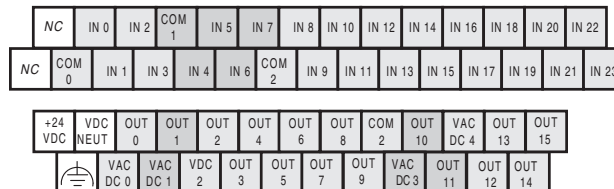

Wire Requirements

Wire Type		Wire Size (2 wire maximum per terminal screw)
Solid	Cu-90°C (194°F)	#14 to #22 AWG
Stranded	Cu-90°C (194°F)	#16 to #22 AWG

Wiring torque = 0.791 Nm (7 in-lb) rated

ATTENTION



Be careful when stripping wires. Wire fragments that fall into the controller could cause damage. Once wiring is complete, be sure the controller is free of all metal fragments before removing the protective debris strip. Failure to remove the strip before operating can cause overheating.

Wiring Recommendation

When wiring without spade lugs, keep the finger-safe covers in place. Loosen the terminal screw and route the wires through the opening in the finger-safe cover. Tighten the terminal screw, making sure the pressure plate secures the wire.

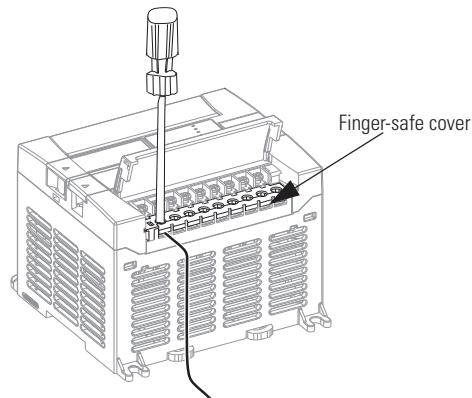

Spade Lug Recommendation

The diameter of the terminal screw head is 5.5 mm (0.220 in.). The input and output terminals of the MicroLogix 1200 controller are designed for the following spade lugs. The terminals will accept a 6.35mm (0.25 in.) wide spade (standard for #6 screw for up to 14 AWG) or a 4 mm (metric #4) fork terminal.

When using spade lugs, use a small, flat-blade screwdriver to pry the finger-safe cover from the terminal blocks. Then loosen the terminal screw.

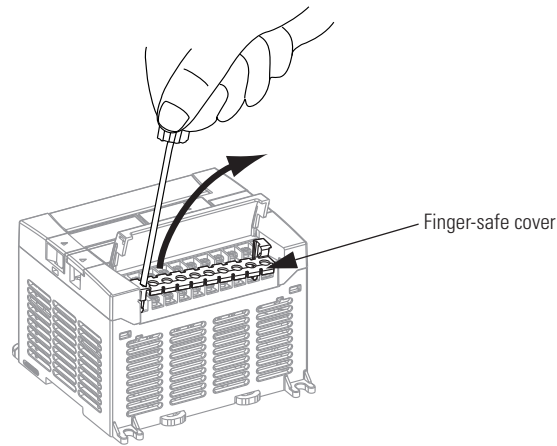

TIP

If you wire the terminal block with the finger-safe cover removed, you may not be able to put it back on the terminal block if the wires are in the way.

Surge Suppression

ATTENTION



Inductive load devices such as motor starters and solenoids require the use of some type of surge suppression to protect the controller output. Switching inductive loads without surge suppression can significantly reduce the life of relay contacts or damage transistor outputs. By using suppression, you also reduce the effects of voltage transients caused by interrupting the current to that inductive device, and prevent electrical noise from radiating into system wiring. Refer to the *MicroLogix 1200 Programmable Controller User Manual*, publication 1762-UM001, for more information on surge suppression.

Grounding the Controller

In solid-state control systems, grounding and wire routing helps limit the effects of noise due to electromagnetic interference (EMI). Run the ground connection from the ground screw of the controller to the ground bus prior to connecting any devices. Use AWG #14 wire. For AC-powered controllers, this connection must be made for safety purposes.

ATTENTION



All devices connected to the RS-232 channel must be referenced to controller ground, or be floating (not referenced to a potential other than ground). Failure to follow this procedure may result in property damage or personal injury.

- For 1762-L24BWA, 1762-L40BWA, 1762-L24BWAR and 1762-L40BWAR controllers:

The COM of the sensor supply is also connected to chassis ground internally. The 24V dc sensor power source should not be used to power output circuits. It should only be used to power input devices.

- For 1762-L24BXB, 1762-L40BXB, 1762-L24BXBR and 1762-L40BXBR controllers:

The VDC NEUT or common terminal of the power supply is also connected to chassis ground internally.

You must also provide an acceptable grounding path for each device in your application. For more information on proper grounding guidelines, refer to the *Industrial Automation Wiring and Grounding Guidelines*, publication 1770-4.1.

Specifications

General Specifications

Description	1762-						
	L24AWA, L24AWAR	L24BWA, L24BWAR	L24BXB, L24BXBR	40AWA, 40AWAR	L40BWA, L40BWAR	L40BXB, L40BXBR	
Dimensions	Height: 90 mm, 104 mm (with DIN latch open) Width: 110 mm, Depth: 87 mm			Height: 90 mm 104 mm (with DIN latch open) Width: 160 mm, Depth: 87 mm			
Shipping Weight	0.9 kg (2.0 lbs)			1.1 kg (2.4 lbs)			
Number of I/O	14 inputs and 10 outputs			24 inputs, 16 outputs			
Power Supply	100 to 240V ac (-15%, +10%) at 47 to 63 Hz		24V dc (-15%, +10%) Class 2 SELV	100 to 240V ac (-15%, +10%) at 47 to 63 Hz		24V dc (-15%, +10%) Class 2 SELV	
Heat Dissipation	Refer to the MicroLogix 1200 Programmable Controllers User Manual.						
Power Supply Inrush	120V ac: 25A for 8 ms 240V ac: 40A for 4 ms		24V dc: 15A for 20 ms	120V ac: 25A for 8 ms 240V ac: 40A for 4 ms		24V dc: 15A for 30 ms	
Power Supply Usage	68 VA	70 VA	27W	80 VA	82 VA	40W	
Power Supply Output	5V dc	400 mA	400 mA ⁽¹⁾	400 mA	600 mA	600 mA ⁽²⁾	600 mA
	24V dc	350 mA	350 mA ⁽¹⁾	350 mA	500 mA	500 mA ⁽²⁾	500 mA
Sensor Power Output	none	24V dc at 250 mA 400 µF max. ⁽¹⁾	none	none	24V dc at 400 mA 400 µF max. ⁽²⁾	none	
Input Circuit Type	120V ac	24V dc sink/source	24V dc sink/source	120V ac	24V dc sink/source	24V dc sink/source	
Output Circuit Type	Relay	Relay	Relay/FET	Relay	Relay	Relay/FET	
Operating Temp.	+0°C to +55°C (+32°F to +131°F) ambient						
Storage Temp.	-40°C to +85°C (-40°F to +185°F) ambient						
Operating Humidity	5% to 95% relative humidity (non-condensing)						
Vibration	Operating: 10 to 500 Hz, 5G, 0.030 in. max. peak-to-peak, 2 hours each axis Relay Operation: 1.5G						

Description	1762-					
	L24AWA, L24AWAR	L24BWA, L24BWAR	L24BXB, L24BXBR	40AWA, 40AWAR	L40BWA, L40BWAR	L40BXB, L40BXBR
Shock	Operating: 30G; 3 pulses each direction, each axis Relay Operation: 7G Non-Operating: 50G panel mounted (40G DIN Rail mounted); 3 pulses each direction, each axis					
Agency Certification	<ul style="list-style-type: none"> • UL 508 • C-UL under CSA C22.2 no. 142 • Class I, Div. 2, Groups A, B, C, D (UL 1604, C-UL under CSA C22.2 no. 213) • CE/C-Tick compliant for all applicable directives 					
Electrical/EMC	The controller has passed testing at the following levels: <ul style="list-style-type: none"> • IEC1000-4-2: 4 kV contact, 8 kV air, 4 kV indirect • IEC1000-4-3: 10V/m, 80 to 1000 MHz, 80% amplitude modulation, +900 MHz keyed carrier • IEC1000-4-4: 2 kV, 5 kHz; communications cable: 1 kV, 5 kHz • IEC1000-4-5: communications cable 1 kV galvanic gun I/O: 2 kV CM (common mode), 1 kV DM (differential mode) AC Power Supply: 4 kV CM (common mode), 2 kV DM (differential mode) DC Power Supply: 500V CM (common mode), 500V DM (differential mode) • IEC1000-4-6: 10V, communications cable 3V 					
Terminal Screw Torque	0.791 Nm (7 in-lb) rated					

⁽¹⁾ Do not allow the total load power consumed by the 5V dc, 24V dc, and sensor power outputs to exceed 12W.

⁽²⁾ Do not allow the total load power consumed by the 5V dc, 24V dc, and sensor power outputs to exceed 16W.

Refer to the MicroLogix 1200 User Manual for system validation worksheets.

Input Specifications

Description	1762-L24AWA, -L40AWA 1762-L24AWAR, -L40AWAR	1762-L24BWA, -L24BXB, -L40BWA, -L40BXB 1762-L24BWAR, -L24BXBR, -L40BWAR, -L40BXBR	
		Inputs 0 through 3	Inputs 4 and higher
On-State Voltage Range	79 to 132V ac	14 to 24V dc (+10% at 55°C/131°F) (+25% at 30°C/86°F)	10 to 24V dc (+10% at 55°C/131°F) (+25% at 30°C/86°F)
Off-State Voltage Range	0 to 20V ac	0 to 5V dc	
Operating Frequency	47 Hz to 63 Hz	0 Hz to 20 kHz	0 Hz to 1 kHz (scan time dependent)
On-State Current:			
<ul style="list-style-type: none"> • minimum • nominal • maximum 	<ul style="list-style-type: none"> • 5.0 mA at 79V ac • 12 mA at 120V ac • 16.0 mA at 132V ac 	<ul style="list-style-type: none"> • 2.5 mA at 14V dc • 7.3 mA at 24V dc • 12.0 mA at 30V dc 	<ul style="list-style-type: none"> • 2.0 mA at 10V dc • 8.9 mA at 24V dc • 12.0 mA at 30V dc
Off-State Leakage Current	2.5 mA max.	1.5 mA min.	
Nominal Impedance	12K Ω at 50 Hz 10K Ω at 60 Hz	3.3K Ω	2.7K Ω
Inrush Current (max.) at 120V ac	250 mA	Not Applicable	

Output Specifications

General

Description	1762			
	-L24AWA -L24BWA -L24AWAR -L24BWAR	-L24BXB -L24BXBR	-L40AWA -L40BWA -L40AWAR -L40BWAR	-L40BXB -L40BXBR
Relay and FET Outputs				
Maximum Controlled Load	1440 VA			
Maximum Continuous Current:				
Current per Group Common	8A	7.5A	8A	8A
Current per Controller	at 150V max	30A or total of per-point loads, whichever is less		
	at 240V max	20A or total of per-point loads, whichever is less		
Relay Outputs				
Turn On Time/Turn Off Time	10 msec (minimum) ⁽¹⁾			
Load Current	10 mA (minimum)			

⁽¹⁾ scan time dependent

Relay Contact Ratings

Maximum Volts	Amperes		Amperes Continuous	Volt-Amperes	
	Make	Break		Make	Break
240V ac	7.5A	0.75A	2.5A ⁽²⁾	1800 VA	180 VA
120V ac	15A	1.5A	2.5A ⁽²⁾	1800 VA	180 VA
125V dc	0.22A ⁽¹⁾		1.0A	28 VA	
24V dc	1.2A ⁽¹⁾		2.0A		

⁽¹⁾ For dc voltage applications, the make/break ampere rating for relay contacts can be determined by dividing 28 VA by the applied dc voltage. For example, 28 VA/48V dc = 0.58A. For dc voltage applications less than 14V, the make/break ratings for relay contacts cannot exceed 2A.

⁽²⁾ 1.5A above 40°C.

BXB FET Output Specifications

Description	General Operation	High Speed Operation ⁽¹⁾ (Output 2 Only)
Power Supply Voltage	24V dc (-15%, +10%)	
On-State Voltage Drop: <ul style="list-style-type: none"> • at maximum load current • at maximum surge current 	<ul style="list-style-type: none"> • 1V dc • 2.5V dc 	<ul style="list-style-type: none"> • Not Applicable • Not Applicable
Current Rating per Point <ul style="list-style-type: none"> • maximum load • minimum load • maximum leakage 	<ul style="list-style-type: none"> • See graphs below. • 1.0 mA • 1.0 mA 	<ul style="list-style-type: none"> • 100 mA • 10 mA • 1.0 mA

Maximum Output Current (temperature dependent):

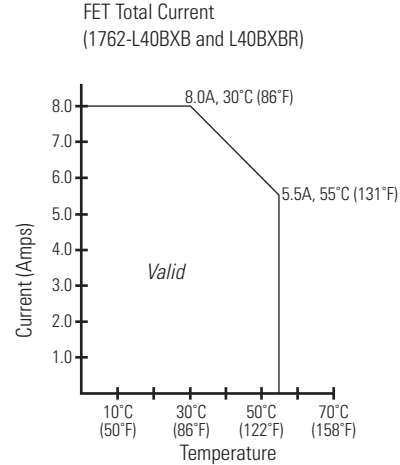
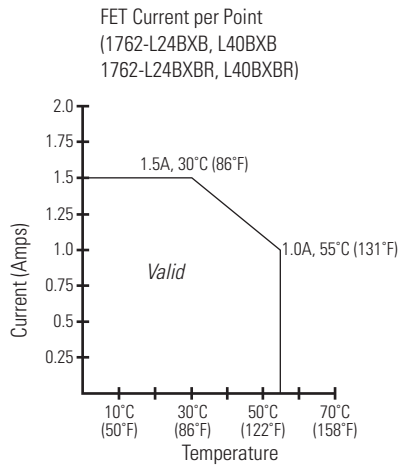

Surge Current per Point: <ul style="list-style-type: none"> • peak current • maximum surge duration • maximum rate of repetition at 30°C (86°F) • maximum rate of repetition at 55°C (131°F) 	<ul style="list-style-type: none"> • 4.0A • 10 msec • once every second • once every 2 seconds 	<ul style="list-style-type: none"> • Not Applicable • Not Applicable • Not Applicable • Not Applicable
--	--	--

Description	General Operation	High Speed Operation ⁽¹⁾ (Output 2 Only)
Turn-On Time (maximum)	0.1 msec	6 µsec
Turn-Off Time (maximum)	1.0 msec	18 µsec
Repeatability (maximum)	n/a	2 µsec
Drift (maximum)	n/a	1 µsec per 5°C (9°F)

⁽¹⁾ Output 2 is designed to provide increased functionality over the other FET outputs. Output 2 may be used like the other FET transistor outputs, but in addition, within a limited current range, it may be operated at a higher speed. Output 2 also provides a pulse train output (PTO) or pulse width modulation output (PWM) function.

Working Voltage

Description	1762-L24AWA, 1762-L40AWA, 1762-L24AWAR, 1762-L40AWAR
Power Supply Input to Backplane Isolation	Verified by one of the following dielectric tests: 1836V ac for 1 second or 2596V dc for 1 second
	265V ac Working Voltage (IEC Class 2 reinforced insulation)
Input Group to Backplane Isolation	Verified by one of the following dielectric tests: 1517V ac for 1 second or 2145V dc for 1 second
	132V ac Working Voltage (IEC Class 2 reinforced insulation)
Input Group to Input Group Isolation	Verified by one of the following dielectric tests: 1517V ac for 1 second or 2145V dc for 1 second
	132V ac Working Voltage (basic insulation)
Output Group to Backplane Isolation	Verified by one of the following dielectric tests: 1836V ac for 1 second or 2596V dc for 1 second
	265V ac Working Voltage (IEC Class 2 reinforced insulation)
Output Group to Output Group Isolation	Verified by one of the following dielectric tests: 1836V ac for 1 second or 2596V dc for 1 second
	265V ac Working Voltage (basic insulation) 150V ac Working Voltage (IEC Class 2 reinforced insulation).

Description	1762-L24BWA, 1762-L40BWA, 1762-L24BWAR, 1762-L40BWAR
Power Supply Input to Backplane Isolation	Verified by one of the following dielectric tests: 1836V ac for 1 second or 2596V dc for 1 second
	265V ac Working Voltage (IEC Class 2 reinforced insulation)
Input Group to Backplane Isolation and Input Group to Input Group Isolation	Verified by one of the following dielectric tests: 1200V ac for 1 second or 1697V dc for 1 second
	75V dc Working Voltage (IEC Class 2 reinforced insulation)
Output Group to Backplane Isolation	Verified by one of the following dielectric tests: 1836V ac for 1 second or 2596V dc for 1 second
	265V ac Working Voltage (IEC Class 2 reinforced insulation).
Output Group to Output Group Isolation	Verified by one of the following dielectric tests: 1836V ac for 1 second or 2596V dc for 1 second
	265V ac Working Voltage (basic insulation) 150V Working Voltage (IEC Class 2 reinforced insulation)

Description	1762-L24BXB, 1762-L40BXB, 1762-L24BXBR, 1762-L40BXBR
Input Group to Backplane Isolation and Input Group to Input Group Isolation	Verified by one of the following dielectric tests: 1200V ac for 1 second or 1697V dc for 1 second
	75V dc Working Voltage (IEC Class 2 reinforced insulation)
FET Output Group to Backplane Isolation	Verified by one of the following dielectric tests: 1200V ac for 1 second or 1697V dc for 1 second
	75V dc Working Voltage (IEC Class 2 reinforced insulation)
Relay Output Group to Backplane Isolation	Verified by one of the following dielectric tests: 1836V ac for 1 second or 2596V dc for 1 second
	265V ac Working Voltage (IEC Class 2 reinforced insulation).
Relay Output Group to Relay Output Group and FET Output Group Isolation	Verified by one of the following dielectric tests: 1836V ac for 1 second or 2596V dc for 1 second
	265V ac Working Voltage (basic insulation) 150V Working Voltage (IEC Class 2 reinforced insulation)

Notes:

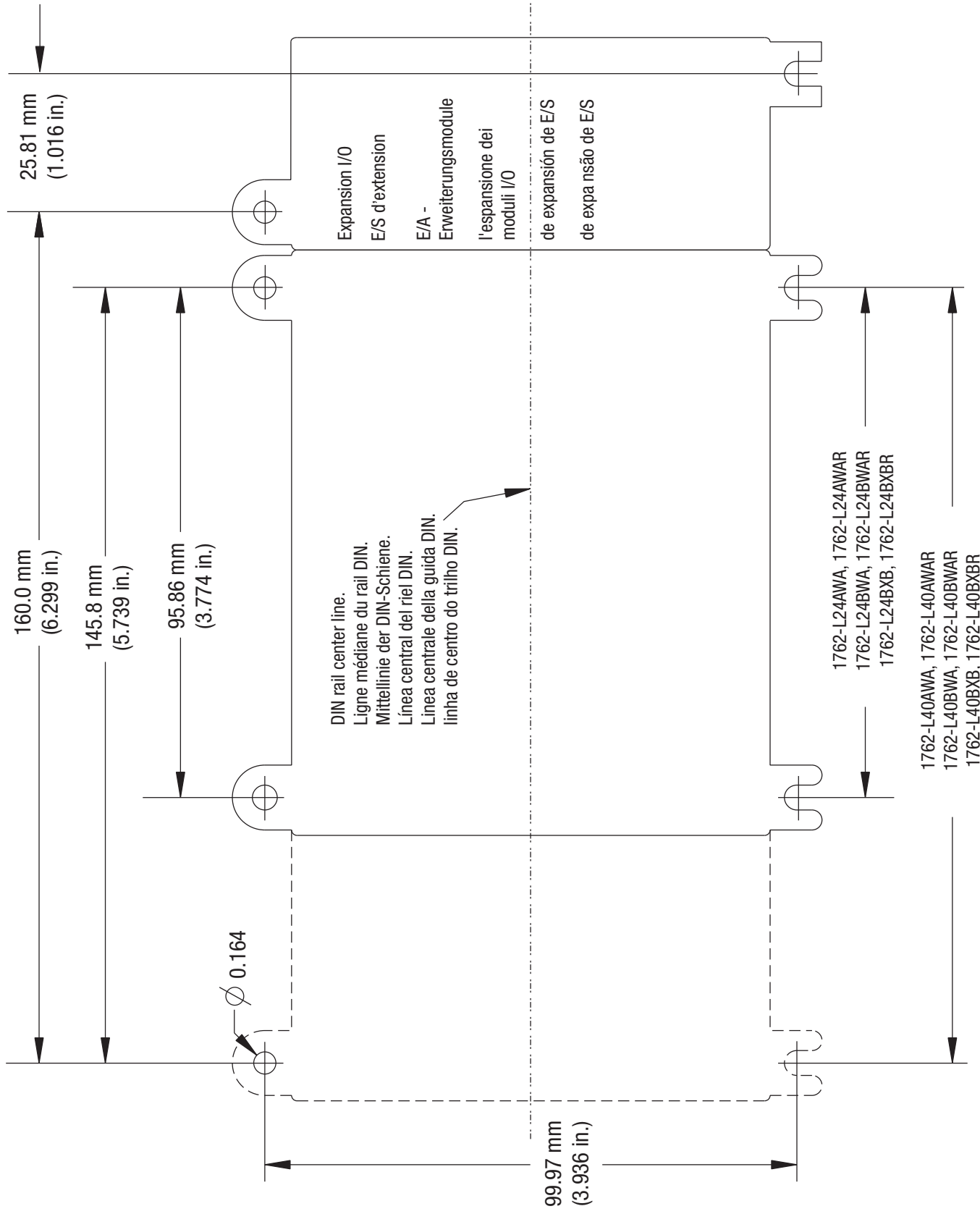

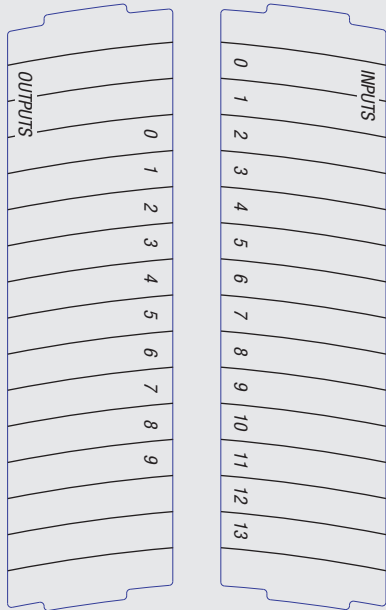

L24AWA L24AWAR

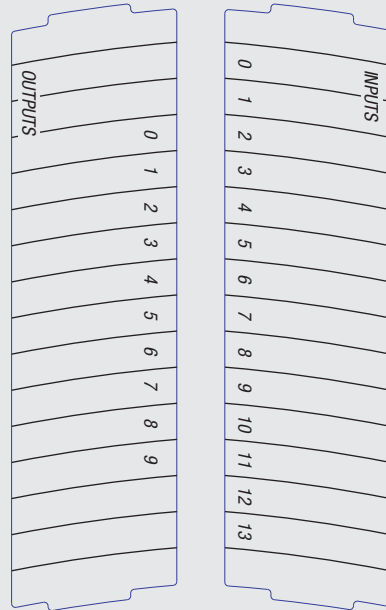

L24BWA L24BWAR

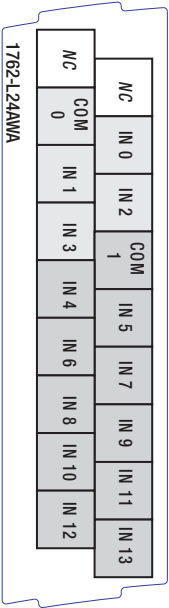
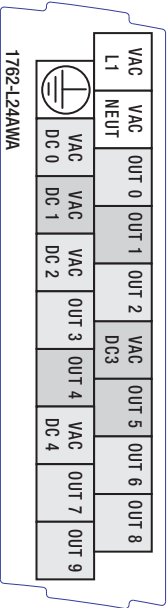

L24AWA L24AWAR

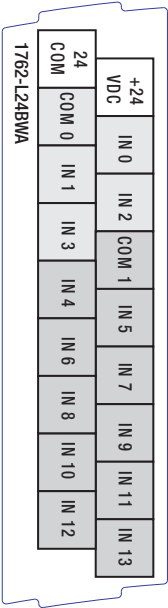
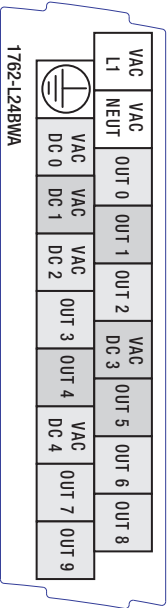

L24BWA L24BWAR



L40AWA L40AWAR

L40BWA L40BWAR

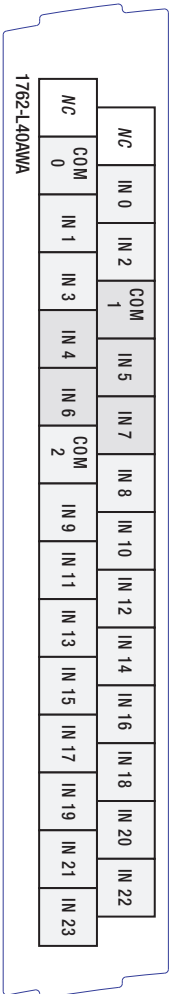
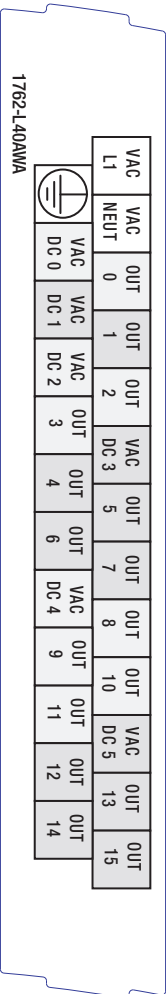

L40AWA L40AWAR

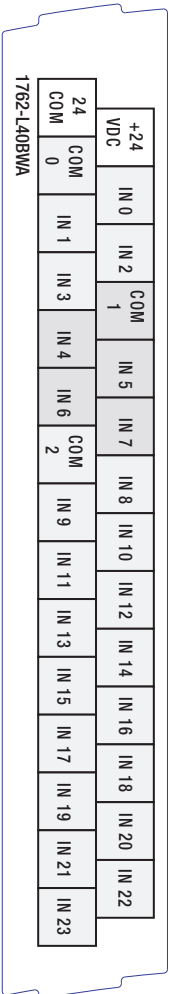
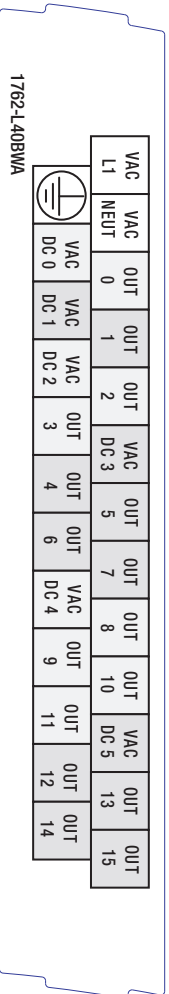

L40BWA L40BWAR

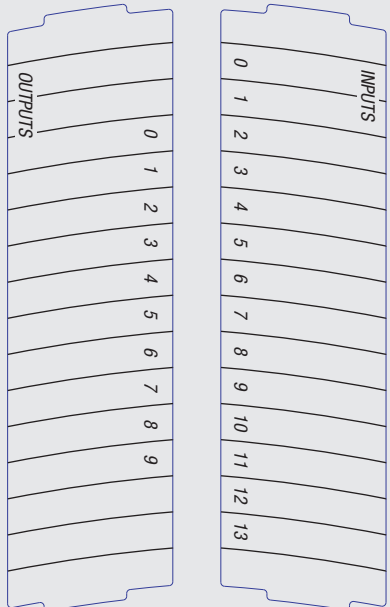

L24BxB L24BxBR

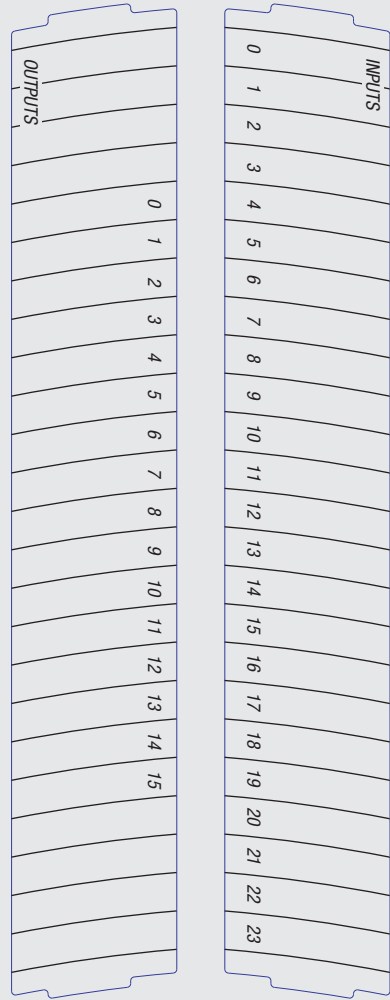

L40BxB L40BxBR

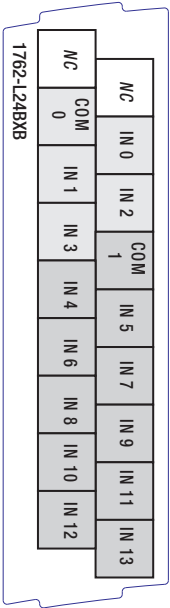
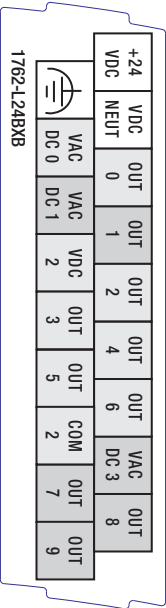

L24BxB L24BxBR

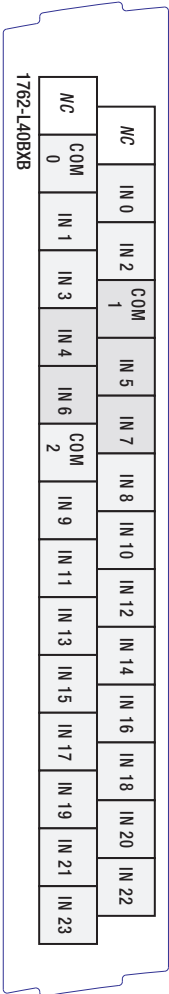
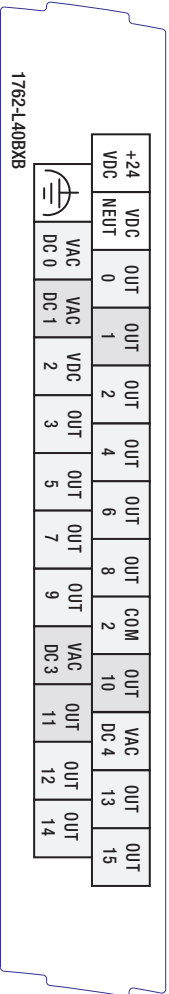

L40BxB L40BxBR

Rockwell Automation Support

Rockwell Automation provides technical information on the Web to assist you in using its products. At <http://support.rockwellautomation.com>, you can find technical manuals, a knowledge base of FAQs, technical and application notes, sample code and links to software service packs, and a MySupport feature that you can customize to make the best use of these tools.

For an additional level of technical phone support for installation, configuration and troubleshooting, we offer TechConnect support programs. For more information, contact your local distributor or Rockwell Automation representative, or visit <http://support.rockwellautomation.com>.

Installation Assistance

If you experience a problem with a hardware module within the first 24 hours of installation, please review the information that's contained in this manual. You can also contact a special Customer Support number for initial help in getting your module up and running:

United States	1.440.646.3434 Monday – Friday, 8am – 5pm EST
Outside United States	Please contact your local Rockwell Automation representative for any technical support issues.

New Product Satisfaction Return

Rockwell Automation tests all of its products to ensure that they are fully operational when shipped from the manufacturing facility. However, if your product is not functioning and needs to be returned, follow these procedures.

United States	Contact your distributor. You must provide a Customer Support case number (see phone number above to obtain one) to your distributor in order to complete the return process.
Outside United States	Please contact your local Rockwell Automation representative for return procedure.

Allen-Bradley, Rockwell Automation, MicroLogix, and TechConnect are trademarks of Rockwell Automation, Inc.

Trademarks not belonging to Rockwell Automation are property of their respective companies.

www.rockwellautomation.com

Power, Control and Information Solutions Headquarters

Americas: Rockwell Automation, 1201 South Second Street, Milwaukee, WI 53204-2496 USA, Tel: (1) 414.382.2000, Fax: (1) 414.382.4444
Europe/Middle East/Africa: Rockwell Automation, Vorstlaan/Boulevard du Souverain 36, 1170 Brussels, Belgium, Tel: (32) 2 663 0600, Fax: (32) 2 663 0640
Asia Pacific: Rockwell Automation, Level 14, Core F, Cyberport 3, 100 Cyberport Road, Hong Kong, Tel: (852) 2887 4788, Fax: (852) 2508 1846

Publication 1762-IN006C-EN-P - September 2009

Supersedes Publication 1762-IN006B-EN-P - March 2008

PN 40072-073-01(7)

Copyright © 2009 Rockwell Automation, Inc. All rights reserved. Printed in Singapore.